

SPECIFICATION FOR APPROVAL

() Preliminary Specification

(◆) Final Specification

Title	15.4" WXGA TFT LCD
-------	--------------------

Customer	DELL
MODEL	

SUPPLIER	LG.Philips LCD Co., Ltd.
*MODEL	LP154WX7
Suffix	TLB1

*When you obtain standard approval,
please use the above model name without suffix

APPROVED BY	SIGNATURE
/	_____
/	_____
/	_____

Please return 1 copy for your confirmation with your signature and comments.

APPROVED BY	SIGNATURE
J.L. Ma / G.Manager	_____
REVIEWED BY	
N.J. Seong / Manager	_____
PREPARED BY	
N.K. Cho / Engineer	_____
T.S. Yun / Engineer	_____

**Products Engineering Dept.
LG. Philips LCD Co., Ltd**

Product Specification

Contents

No	ITEM	Page
	COVER	1
	CONTENTS	2
	RECORD OF REVISIONS	3
1	GENERAL DESCRIPTION	4
2	ABSOLUTE MAXIMUM RATINGS	5
3	ELECTRICAL SPECIFICATIONS	
3-1	ELECTRICAL CHARACTERISTICS	6
3-2	INTERFACE CONNECTIONS	8
3-3	LVDS SIGNAL TIMING SPECIFICATIONS	9
3-4	SIGNAL TIMING SPECIFICATIONS	11
3-5	SIGNAL TIMING WAVEFORMS	11
3-6	COLOR INPUT DATA REFERENCE	12
3-7	POWER SEQUENCE	13
4	OPTICAL SPECIFICATIONS	14
5	MECHANICAL CHARACTERISTICS	17
6	RELIABILITY	24
7	INTERNATIONAL STANDARDS	
7-1	SAFETY	25
7-2	EMC	25
8	PACKING	
8-1	DESIGNATION OF LOT MARK	26
8-2	PACKING FORM	26
9	PRECAUTIONS	27
A	APPENDIX. Enhanced Extended Display Identification Data	29

Product Specification

1. General Description

The LP154WX7 is a Color Active Matrix Liquid Crystal Display with an integral White LED backlight system. The matrix employs a-Si Thin Film Transistor as the active element. It is a transmissive type display operating in the normally white mode. This TFT-LCD has 15.4 inches diagonally measured active display area with WXGA resolution(800 vertical by 1280 horizontal pixel array). Each pixel is divided into Red, Green and Blue sub-pixels or dots which are arranged in vertical stripes. Gray scale or the brightness of the sub-pixel color is determined with a 6-bit gray scale signal for each dot, thus, presenting a palette of more than 262,144 colors.

The LP154WX7 has been designed to apply the interface method that enables low power, high speed, low EMI.

The LP154WX7 is intended to support applications where thin thickness, low power are critical factors and graphic displays are important. In combination with the vertical arrangement of the sub-pixels, the LP154WX7 characteristics provide an excellent flat display for office automation products such as Notebook PC.

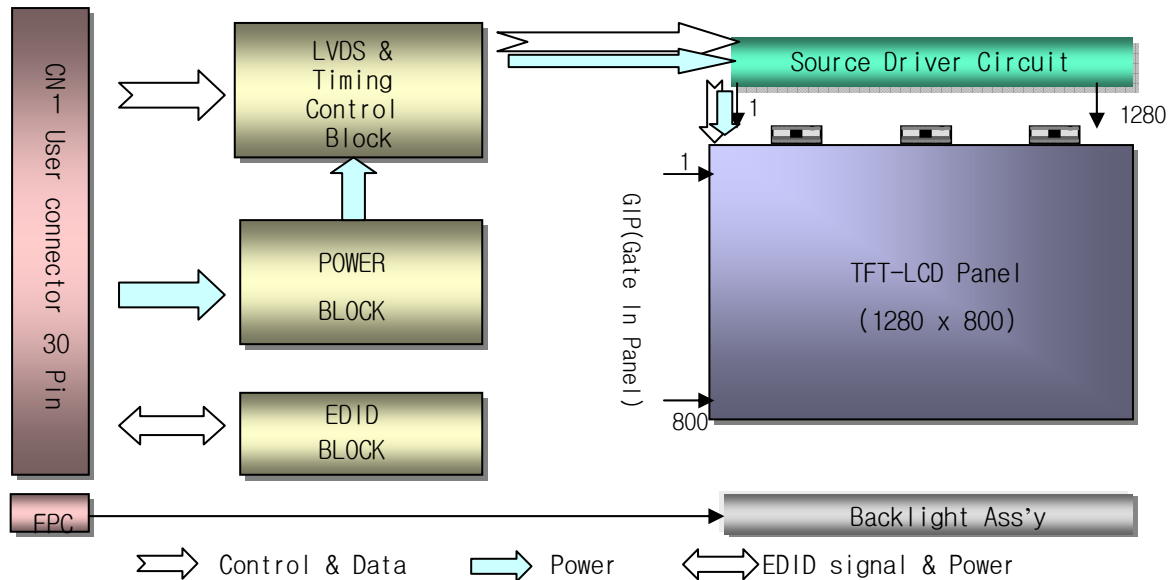

General Features

Active Screen Size	15.4 inches diagonal
Outline Dimension	344.0(H.) × 222.0(V) × 6.5(D,Max) [mm]
Pixel Pitch	0.2588mm × 0.2588 mm
Pixel Format	1280 horiz. By 800 vert. Pixels RGB strip arrangement
Color Depth	6-bit, 262,144 colors
Luminance, White	220 cd/m ² (Typ.5 point)
Power Consumption	TBD
Weight	500g(Max.)
Display Operating Mode	Transmissive mode, normally white
Surface Treatment	Glare treatment of the front polarizer
RoHS Comply	Yes

Product Specification

2. Absolute Maximum Ratings

The following are maximum values which, if exceeded, may cause faulty operation or damage to the unit.

Table 1. ABSOLUTE MAXIMUM RATINGS

Parameter	Symbol	Values		Units	Notes
		Min	Max		
Power Input Voltage	VCC	-0.3	4.0	Vdc	at 25 ± 5°C
Operating Temperature	TOP	0	50	°C	1
Storage Temperature	HST	-20	60	°C	1
Operating Ambient Humidity	HOP	10	90	%RH	1
Storage Humidity	HST	10	90	%RH	1

Note : 1. Temperature and relative humidity range are shown in the figure below.
Wet bulb temperature should be 39°C Max, and no condensation of water.

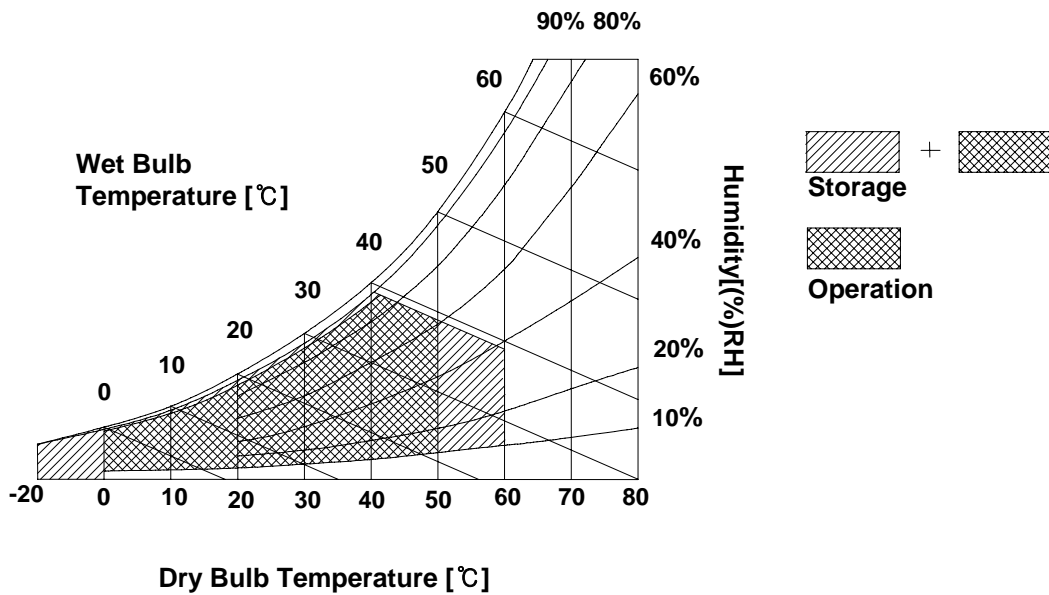

3. Electrical Specifications

3-1. Electrical Characteristics

The LP154WX7 requires two power inputs. One is employed to power the LCD electronics and to drive the TFT array and liquid crystal. The second input which powers the White LED, is typically generated by an LED Driver. The LED Driver is an external unit to the LCD.

Table 2. ELECTRICAL CHARACTERISTICS

Parameter	Symbol	Values			Unit	Notes
		Min	Typ	Max		
MODULE :						
Power Supply Input Voltage	VCC	3.0	3.3	3.6	V _{DC}	
Power Supply Input Current	I _{CC} Mosaic	-	TBD		mA	1
Power Consumption	P _C Mosaic	-	TBD			
Differential Impedance	Z _m	90	100	110	Ohm	2
LED :						
Operating Current per string	I _{LED}	5.0	20.0	21.0	mA	3
Power Consumption	P _{BL}		3.4	3.7	W	4
Life Time		15,000			Hrs	5

Note)

1. The specified current and power consumption are under the Vcc = 3.3V , 25°C , fv = 60Hz condition whereas Mosaic pattern is displayed and fv is the frame frequency.

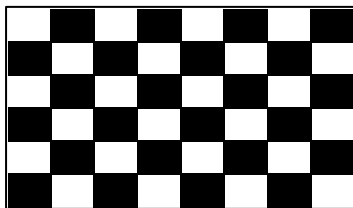

2. This impedance value is needed to proper display and measured form LVDS Tx to the mating connector.
3. The typical operating current is for the typical surface luminance (L_{WH}) in optical characteristics.
I_{LED} is the current of each LEDs' string, LED backlight has 6 strings on it.
4. The LED power consumption shown above does not include power of external LED driver circuit for typical current condition.
5. The life time is determined as the time at which brightness of LED is 50% compare to that of minimum value specified in table 8.

3-2. Interface Connections

This LCD employs two interface connections, a 30 pin connector is used for the module electronics interface and the other connector is used for the integral backlight system.

The electronics interface connector is a model FI-XB30SRL-HF11 manufactured by JAE.

Table 3. MODULE CONNECTOR PIN CONFIGURATION (CN1)

Pin	Symbol	Description	Notes
1	GND	Ground	<p>1, Interface chips 1.1 LCD : SW, SW0612B (LCD Controller) including LVDS Receiver 1.2 System : THC63LVD823A or equivalent * Pin to Pin compatible with LVDS</p> <p>2. Connector 2.1 LCD : FI-XB30SRL-HF11, JAE it's compatible. 2.2 Mating : FI-X30M or equivalent. 2.3 Connector pin arrangement</p>  <p>[LCD Module Rear View]</p>
2	VCC	Power Supply, 3.3V Typ.	
3	VCC	Power Supply, 3.3V Typ.	
4	V EEDID	DDC 3.3V power	
5	NC	Reserved for supplier test point	
6	Clk EEDID	DDC Clock	
7	DATA EEDID	DDC Data	
8	R _{IN} 0-	Negative LVDS differential data input	
9	R _{IN} 0+	Positive LVDS differential data input	
10	GND	Ground	
11	R _{IN} 1-	Negative LVDS differential data input	
12	R _{IN} 1+	Positive LVDS differential data input	
13	GND	Ground	
14	R _{IN} 2-	Negative LVDS differential data input	
15	R _{IN} 2+	Positive LVDS differential data input	
16	GND	Ground	
17	CLKIN-	Negative LVDS differential clock input	
18	CLKIN+	Positive LVDS differential clock input	
19	GND	Ground	
20	NC	No Connect	
21	NC	No Connect	
22	GND	Ground	
23	NC	No Connect	
24	NC	No Connect	
25	GND	Ground	
26	NC	No Connect	
27	NC	No Connect	
28	GND	Ground	
29	NC	No Connect	
30	NC	No Connect	

Table 4. LED FPC CONNECTOR PIN CONFIGURATION)

Pin	Symbol	Description	Notes
1	FB1	LED Channel 1 Cathode	Connector FH33-12S-0.5SH, Hirose it's compatible.
2	FB2	LED Channel 2 Cathode	
3	FB3	LED Channel 3 Cathode	
4	FB4	LED Channel 4 Cathode	
5	FB5	LED Channel 5 Cathode	
6	FB6	LED Channel 6 Cathode	
7	NC	No Connect	
8	NC	No Connect	
9	NC	No Connect	
10	Vin	LED Power (LED Anode)	
11	Vin	LED Power (LED Anode)	
12	Vin	LED Power (LED Anode)	

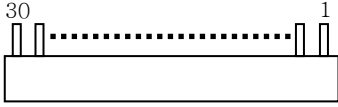
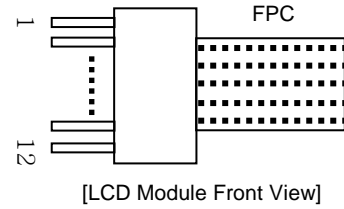

3-3. LVDS Signal Timing Specifications

3-3-1. DC Specification

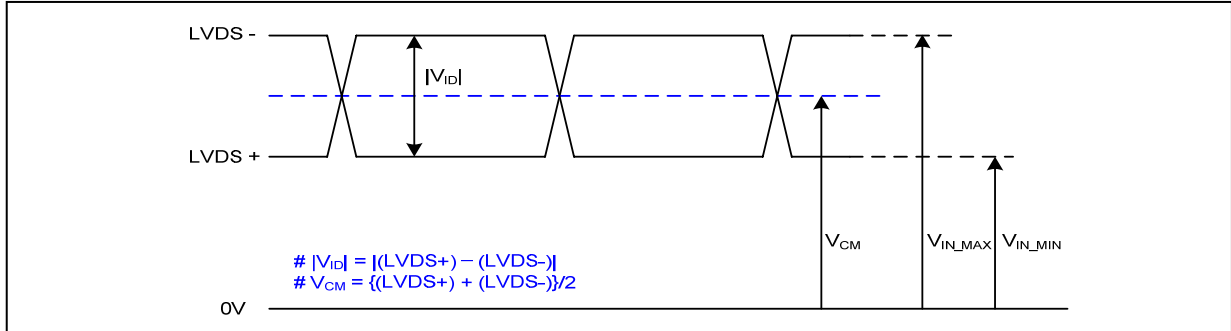

Description	Symbol	Min	Max	Unit	Notes
LVDS Differential Voltage	$ V_{ID} $	100	600	mV	-
LVDS Common mode Voltage	V_{CM}	0.6	1.8	V	-
LVDS Input Voltage Range	V_{IN}	0.3	2.1	V	-

3-3-2. AC Specification

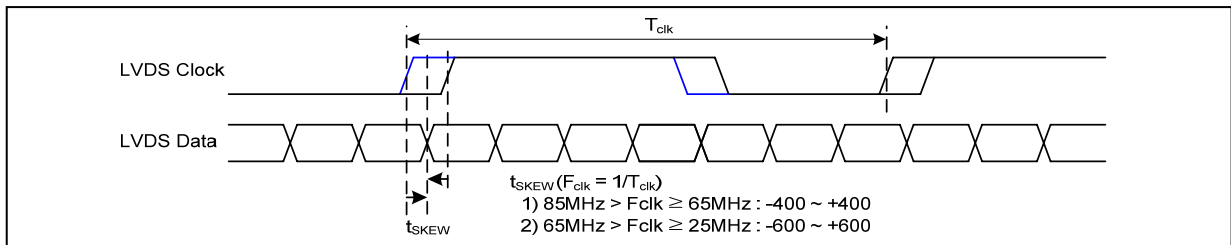

Description	Symbol	Min	Max	Unit	Notes
LVDS Clock to Data Skew Margin	t_{SKEW}	- 400	+ 400	ps	$85MHz > F_{clk} \geq 65MHz$
	t_{SKEW}	- 600	+ 600	ps	$65MHz > F_{clk} \geq 25MHz$
LVDS Clock to Clock Skew Margin (Even to Odd)	t_{SKEW_EO}	- 1/7	+ 1/7	T_{clk}	-
Maximum deviation of input clock frequency during SSC	F_{DEV}	-	± 3	%	-
Maximum modulation frequency of input clock during SSC	F_{MOD}	-	200	KHz	-

Product Specification

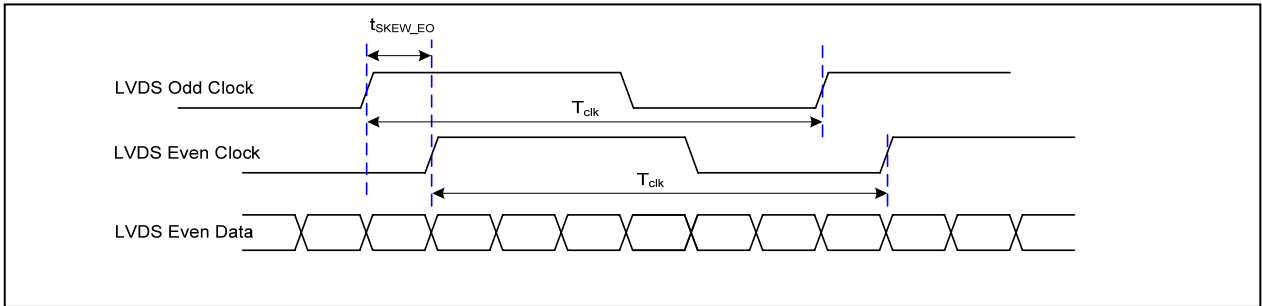

< Clock skew margin between channel >

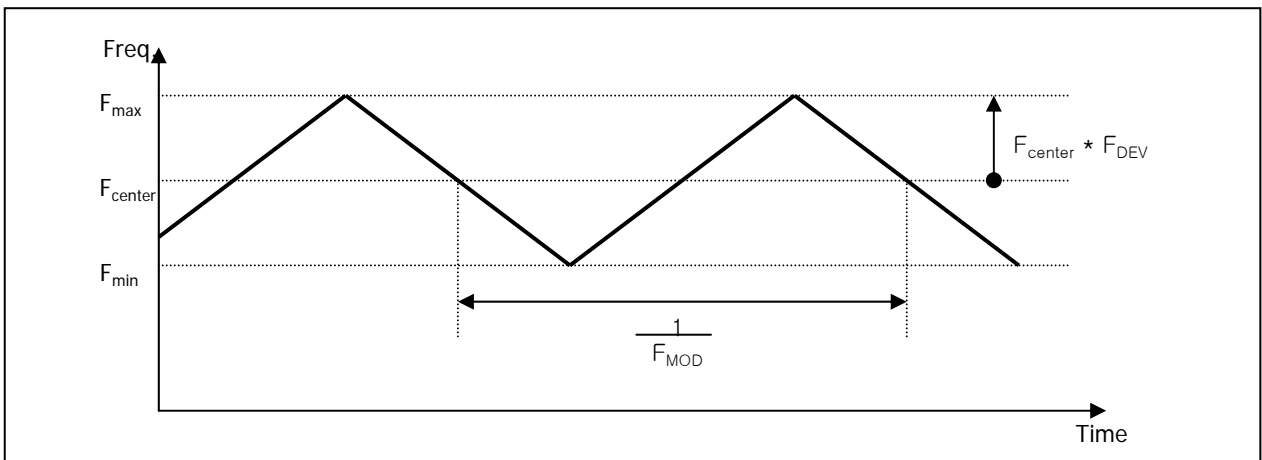

< Spread Spectrum >

3-3-3. Data Format

1) LVDS 1 Port

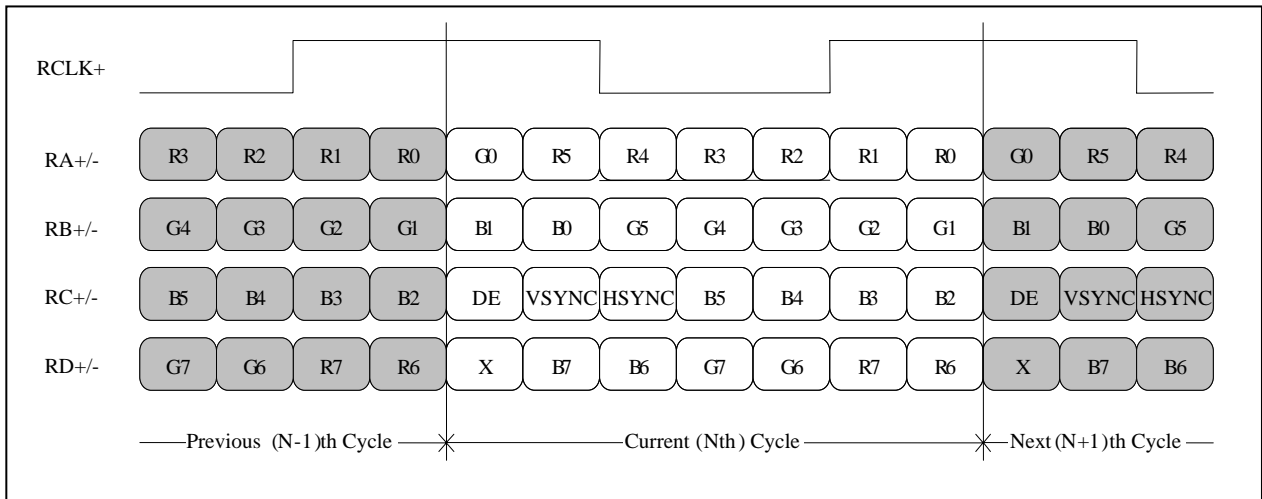

< LVDS Data Format >

3-4. Signal Timing Specifications

This is the signal timing required at the input of the User connector. All of the interface signal timing should be satisfied with the following specifications and specifications of LVDS Tx/Rx for its proper operation.

Table 5. TIMING TABLE

ITEM	Symbol	Min	Typ	Max	Unit	Note
DCLK	Frequency	f_{CLK}	66.9	69.3	73.9	MHz
Hsync	Period	T_{hp}	1376	1408	1480	tCLK
	Width	t_{WH}	24	32	40	
	Width-Active	t_{WHA}	1280	1280	1280	
Vsync	Period	t_{VP}	810	820	832	tHP
	Width	t_{WV}	2	4	6	
	Width-Active	t_{WVA}	800	800	800	
Data Enable	Horizontal back porch	t_{HBP}	56	72	96	tCLK
	Horizontal front porch	t_{HFP}	16	24	64	
	Vertical back porch	t_{VBP}	6	12	18	tHP
	Vertical front porch	t_{VFP}	2	4	8	

3-5. Signal Timing Waveforms

Condition : VCC = 3.3V

Data Enable, Hsync, Vsync

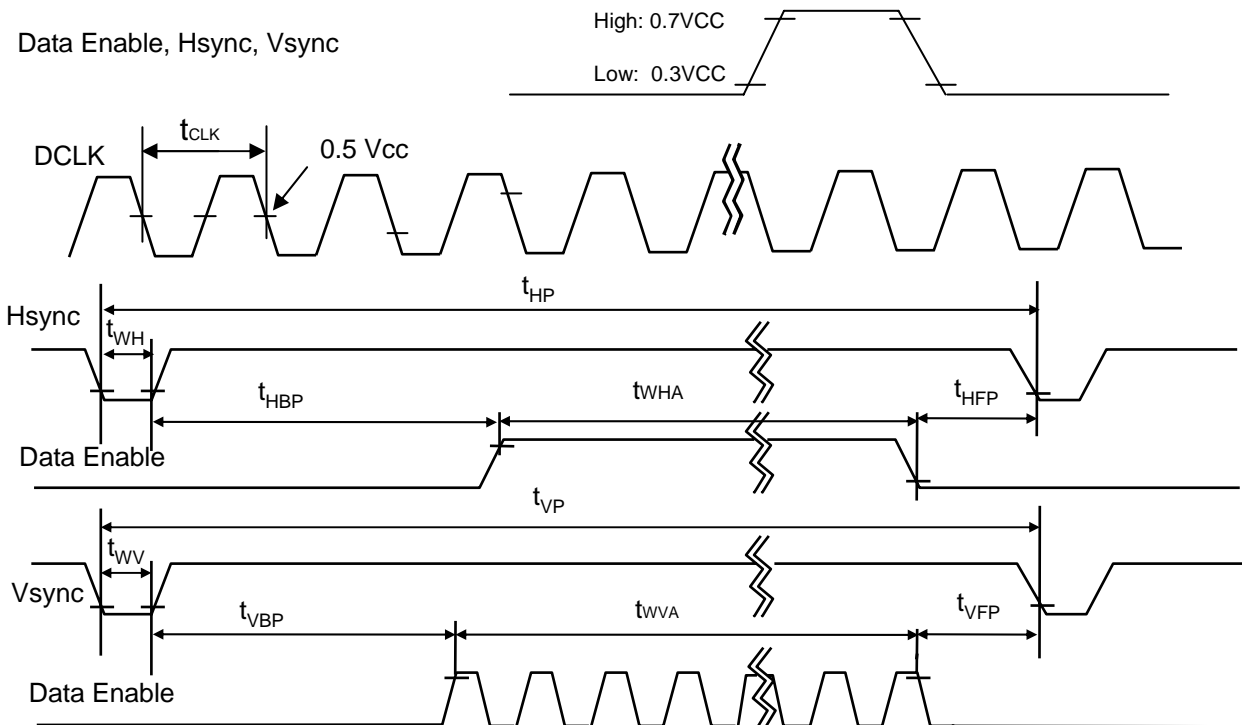

3-6. Color Input Data Reference

The brightness of each primary color (red, green and blue) is based on the 6-bit gray scale data input for the color ; the higher the binary input, the brighter the color. The table below provides a reference for color versus data input.

Table 6. COLOR DATA REFERENCE

Color		Input Color Data																	
		RED						GREEN						BLUE					
		MSB				LSB		MSB				LSB		MSB		LSB			
		R 5	R 4	R 3	R 2	R 1	R 0	G 5	G 4	G 3	G 2	G 1	G 0	B 5	B 4	B 3	B 2	B 1	B 0
Basic Color	Black	0	0	0	0	0	0	0	0	0	0	0	0	0	0	0	0	0	0
	Red	1	1	1	1	1	1	0	0	0	0	0	0	0	0	0	0	0	0
	Green	0	0	0	0	0	0	1	1	1	1	1	1	0	0	0	0	0	0
	Blue	0	0	0	0	0	0	0	0	0	0	0	0	1	1	1	1	1	1
	Cyan	0	0	0	0	0	0	1	1	1	1	1	1	1	1	1	1	1	1
	Magenta	1	1	1	1	1	1	0	0	0	0	0	0	1	1	1	1	1	1
	Yellow	1	1	1	1	1	1	1	1	1	1	1	1	0	0	0	0	0	0
	White	1	1	1	1	1	1	1	1	1	1	1	1	1	1	1	1	1	1
RED	RED (00)	0	0	0	0	0	0	0	0	0	0	0	0	0	0	0	0	0	0
	RED (01)	0	0	0	0	0	1	0	0	0	0	0	0	0	0	0	0	0	0
					
	RED (62)	1	1	1	1	1	0	0	0	0	0	0	0	0	0	0	0	0	0
	RED (63)	1	1	1	1	1	1	0	0	0	0	0	0	0	0	0	0	0	0
GREEN	GREEN (00)	0	0	0	0	0	0	0	0	0	0	0	0	0	0	0	0	0	0
	GREEN (01)	0	0	0	0	0	0	0	0	0	0	0	1	0	0	0	0	0	0
					
	GREEN (62)	0	0	0	0	0	0	1	1	1	1	1	0	0	0	0	0	0	0
	GREEN (63)	0	0	0	0	0	0	1	1	1	1	1	1	0	0	0	0	0	0
BLUE	BLUE (00)	0	0	0	0	0	0	0	0	0	0	0	0	0	0	0	0	0	0
	BLUE (01)	0	0	0	0	0	0	0	0	0	0	0	0	0	0	0	0	0	1
					
	BLUE (62)	0	0	0	0	0	0	0	0	0	0	0	0	1	1	1	1	1	0
	BLUE (63)	0	0	0	0	0	0	0	0	0	0	0	0	1	1	1	1	1	1

3-7. Power Sequence

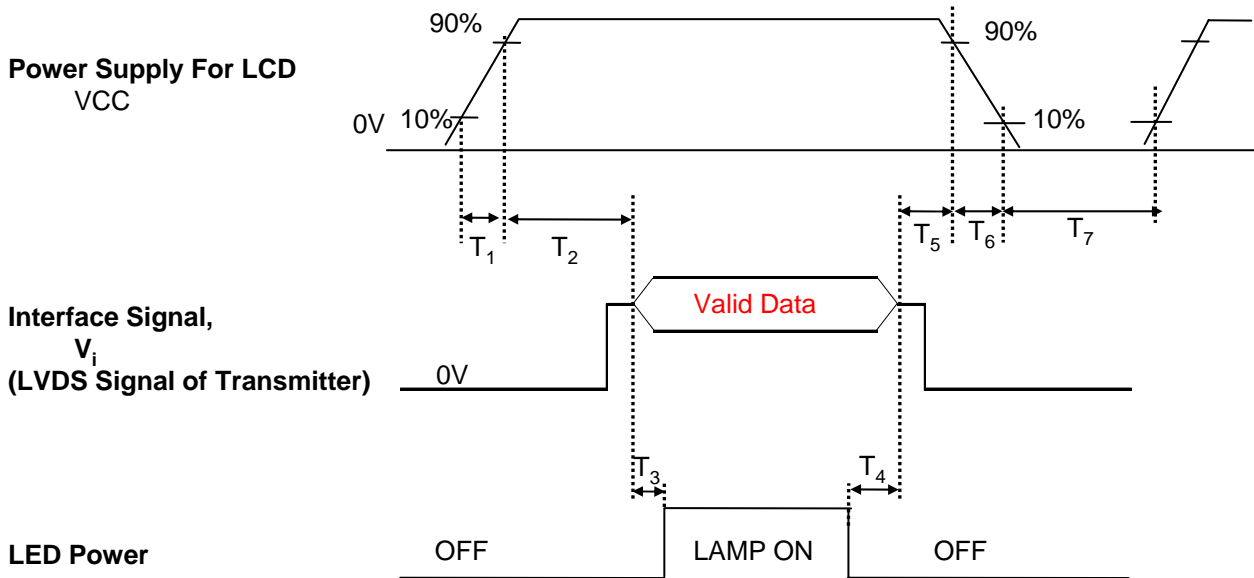

Table 7. POWER SEQUENCE TABLE

Parameter	Value			Units
	Min.	Typ.	Max.	
T ₁	0.5	-	10	(ms)
T ₂	0	-	50	(ms)
T ₃	200	-	-	(ms)
T ₄	200	-	-	(ms)
T ₅	0	-	50	(ms)
T ₆	0	-	10	(ms)
T ₇	400	-	-	(ms)

Note)

1. Valid Data is Data to meet "3-3. LVDS Signal Timing Specifications"
2. Please avoid floating state of interface signal at invalid period.
3. When the interface signal is invalid, be sure to pull down the power supply for LCD VCC to 0V.
4. LED power must be turn on after power supply for LCD and interface signal are valid.

4. Optical Specification

Optical characteristics are determined after the unit has been 'ON' and stable for approximately 30 minutes in a dark environment at 25°C. The values specified are at an approximate distance 50cm from the LCD surface at a viewing angle of Φ and Θ equal to 0°.

FIG. 1 presents additional information concerning the measurement equipment and method.

FIG. 1 Optical Characteristic Measurement Equipment and Method

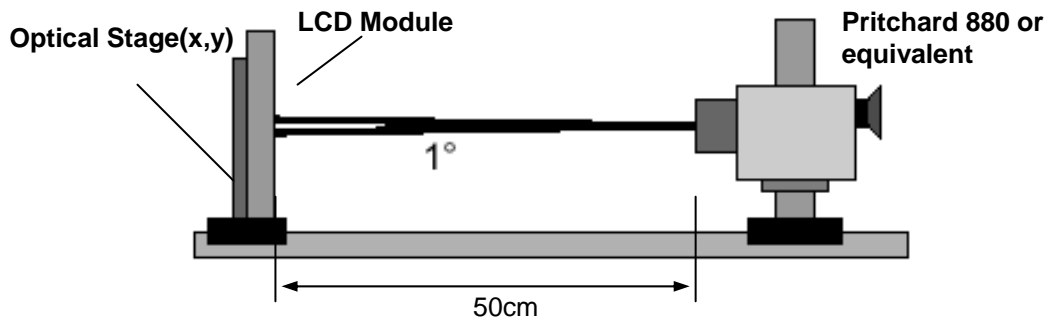

Table 8. OPTICAL CHARACTERISTICS

$T_a=25^\circ\text{C}$, $V_{CC}=3.3\text{V}$, $f_v=60\text{Hz}$, $f_{CLK}=69.3\text{MHz}$, $I_{LED}=20.0\text{mA}$

Parameter	Symbol	Values			Units	Notes
		Min	Typ	Max		
Contrast Ratio	CR	500	-	-		1
Surface Luminance, white	L_{WH}	200	220	-	cd/m ²	2
Luminance Variation	δ_{WHITE}	-	1.4	1.6		3
Response Time	T_{R+T_D}		16		ms	4
Color Coordinates						
RED	RX		TBD			
	RY		TBD			
GREEN	GX		TBD			
	GY		TBD			
BLUE	BX		TBD			
	BY		TBD			
WHITE	WX	0.283	0.313	0.343		
	WY	0.299	0.329	0.359		
Viewing Angle						
x axis, right($\Phi=0^\circ$)	Θ_r	40	-	-	degree	5
x axis, left ($\Phi=180^\circ$)	Θ_l	40	-	-	degree	
y axis, up ($\Phi=90^\circ$)	Θ_u	10	-	-	degree	
y axis, down ($\Phi=270^\circ$)	Θ_d	30	-	-	degree	
Gray Scale						6

Product Specification

Note)

1. Contrast Ratio(CR) is defined mathematically as

$$\text{Contrast Ratio} = \frac{\text{Surface Luminance with all white pixels}}{\text{Surface Luminance with all black pixels}}$$

2. Surface luminance is the average of 5 point across the LCD surface 50cm from the surface with all pixels displaying white. For more information see FIG 1.

$$L_{WH} = \text{Average}(L_1, L_2, \dots L_5)$$

3. The variation in surface luminance , The panel total variation (δ_{WHITE}) is determined by measuring L_N at each test position 1 through 13 and then defined as followed numerical formula.
For more information see FIG 2.

$$\delta_{WHITE} = \frac{\text{Maximum}(L_1, L_2, \dots L_{13})}{\text{Minimum}(L_1, L_2, \dots L_{13})}$$

4. Response time is the time required for the display to transition from white to black (rise time, Tr_R) and from black to white(Decay Time, Tr_D). For additional information see FIG 3.

5. Viewing angle is the angle at which the contrast ratio is greater than 10. The angles are determined for the horizontal or x axis and the vertical or y axis with respect to the z axis which is normal to the LCD surface. For more information see FIG 4.

6. Gray scale specification

* $f_V = 60\text{Hz}$

Gray Level	Luminance [%] (Typ)
L0	TBD
L7	TBD
L15	TBD
L23	TBD
L31	TBD
L39	TBD
L47	TBD
L55	TBD
L63	100

Product Specification

FIG. 2 Luminance

<measuring point for surface luminance & measuring point for luminance variation>

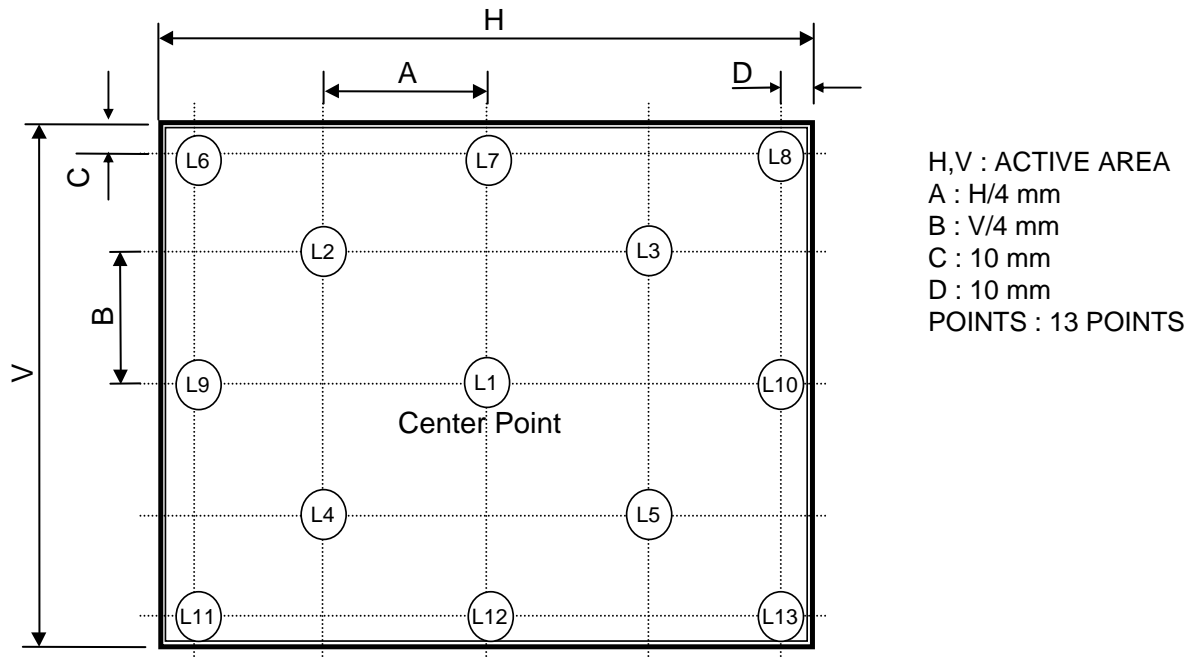
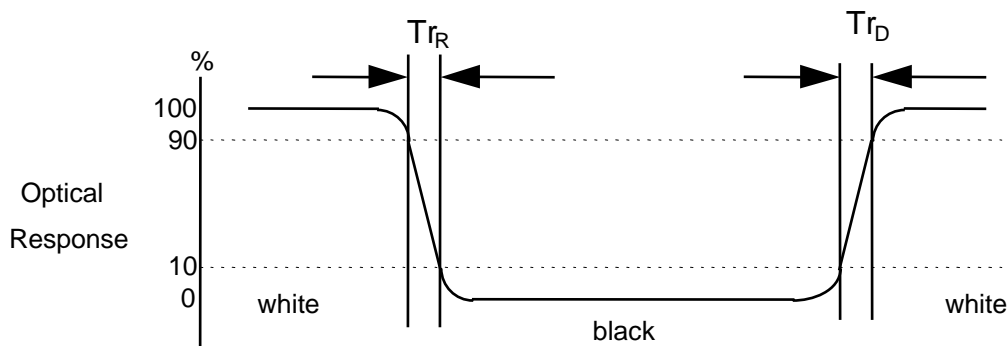

FIG. 3 Response Time

The response time is defined as the following figure and shall be measured by switching the input signal for “black” and “white”.



5. Mechanical Characteristics

The contents provide general mechanical characteristics for the model LP154WX7. In addition the figures in the next page are detailed mechanical drawing of the LCD.

Outline Dimension	Horizontal	344.0 ± 0.5mm
	Vertical	222.0 ± 0.5mm
	Thickness	6.5mm (max)
Bezel Area	Horizontal	335.0 ± 0.5mm
	Vertical	210.7 ± 0.5mm
Active Display Area	Horizontal	331.2 mm
	Vertical	207.0 mm
Weight	500g(Max)	
Surface Treatment	Glare treatment of the front polarizer	

Product Specification

<FRONT VIEW>

Note) Unit:[mm], General tolerance: $\pm 0.5\text{mm}$

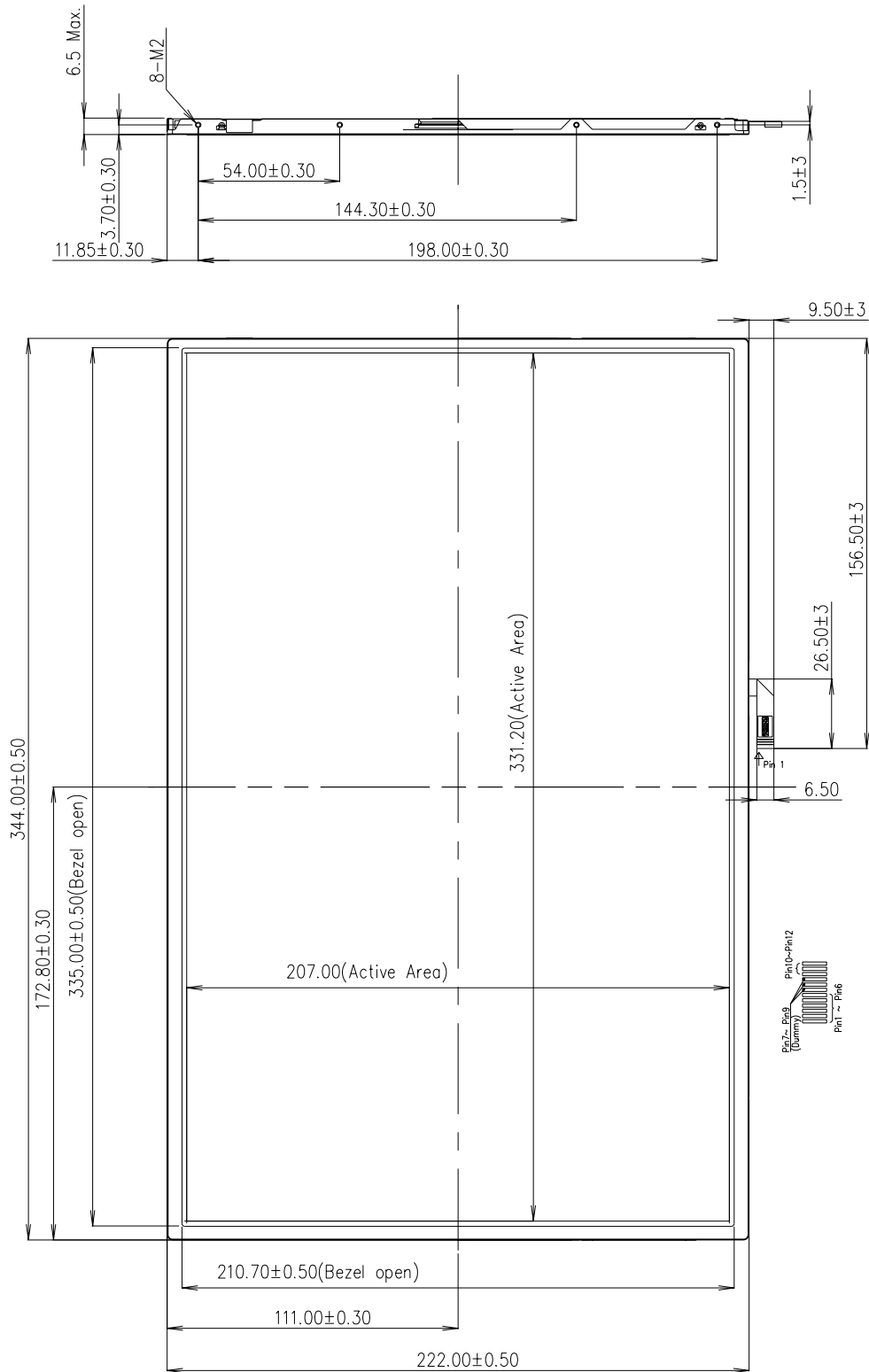

Product Specification

<REAR VIEW>

Note) Unit:[mm], General tolerance: $\pm 0.5\text{mm}$

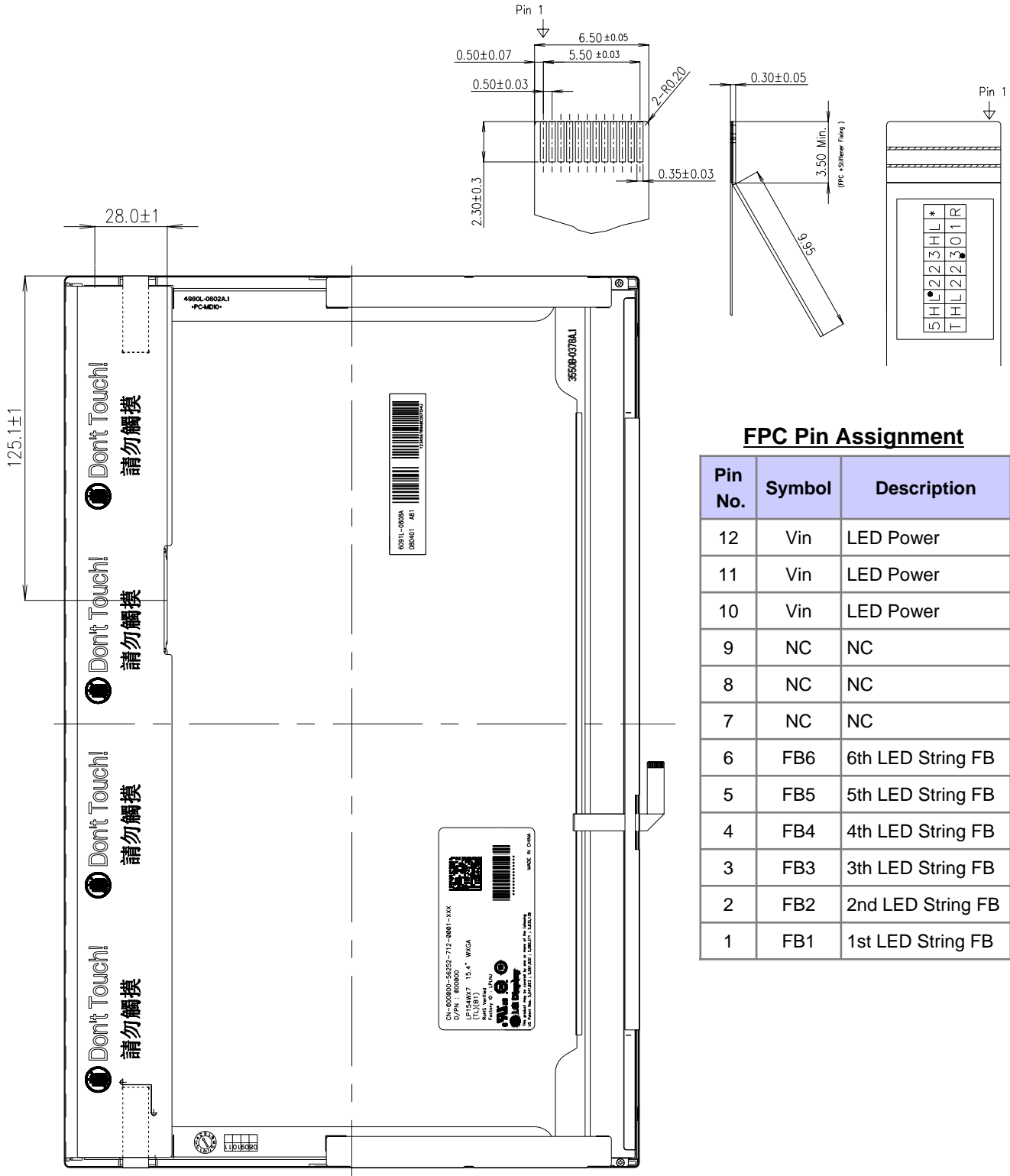

FPC Pin Assignment

Pin No.	Symbol	Description
12	Vin	LED Power
11	Vin	LED Power
10	Vin	LED Power
9	NC	NC
8	NC	NC
7	NC	NC
6	FB6	6th LED String FB
5	FB5	5th LED String FB
4	FB4	4th LED String FB
3	FB3	3th LED String FB
2	FB2	2nd LED String FB
1	FB1	1st LED String FB

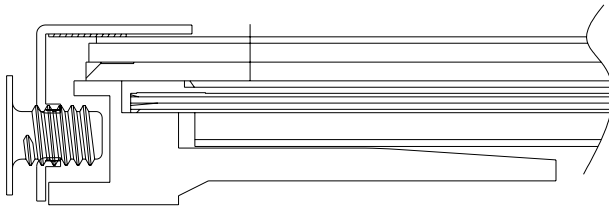
Product Specification**[DETAIL DESCRIPTION OF SIDE MOUNTING SCREW]**

- * Screw Length(A) : Max : 2.5, Min : 2.0
- * Screw Depth(B) : Min 2.5
- * Screw Torque : Max 2.5kgf.cm (Measurement Gauge:Torque Meter)

Notes : 1. Screw plated through the method of non-electrolytic nickel plating is preferred to reduce possibility that results in vertical and/or horizontal line defect due to the conductive particles from screw surface.

Product Specification

LPL Proposal for system cover design.(Appendix)

1	Gap check for securing the enough gap between LCM and System cover.	
<p>The diagram illustrates the assembly of the LCM and system cover. On the left, a top-down view of the LCM reflector side is shown with various colored layers. In the center, a cross-sectional view shows the LCM with a 'Max thickness' dimension and a 'A boundary line' indicated by a red dashed line. On the right, a 'Sponge' is shown between the LCM and the 'System cover'.</p>		
Define	<p>1.Rear side of LCM is sensitive against external stress,and previous check about interference is highly needed.</p> <p>2.In case there is something from system cover comes into the boundary above,mechanical interference may cause the FOS defects. (Eg:Ripple,White spot..)</p>	
2	Check if antenna cable is sufficiently apart from T-CON of LCD Module.	
Define	<p>The diagram shows two scenarios for antenna cable placement. The 'NO GOOD' scenario shows the antenna cable overlapping the T-CON area. The 'GOOD' scenario shows the antenna cable placed away from the T-CON area.</p>	
1.If system antenna is overlapped with T-CON,it might be cause the noise.		

Product Specification

LPL Proposal for system cover design.

3	Gap check for securing the enough gap between LCM and System hinge.	
Define	<p>1. At least 2.0mm of gap needs to be secured to prevent the shock related defects.</p> <p>2. "L" type of hinge is recommended than "I" type under shock test.</p>	
4	Checking the path of the System wire.	
Define	<p>1. COF area needs to be handled with care.</p> <p>2. GOOD → Wire path design to system side. OK → Wire path is located between COFs. BAD → Wire path overlapped with COF area.</p>	

LPL Proposal for system cover design.

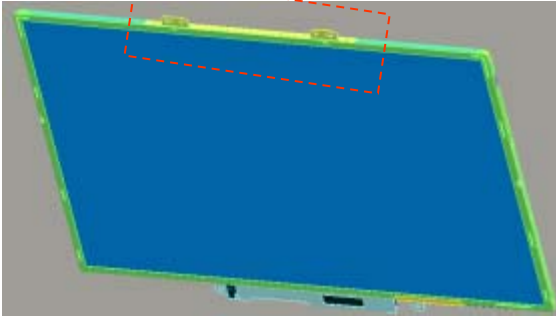
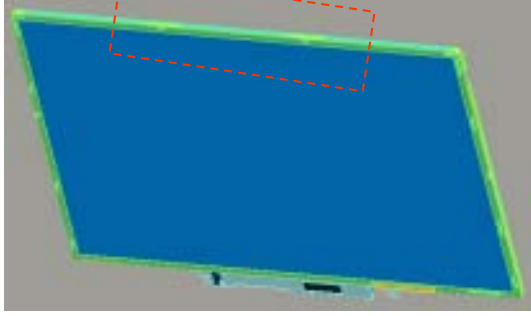
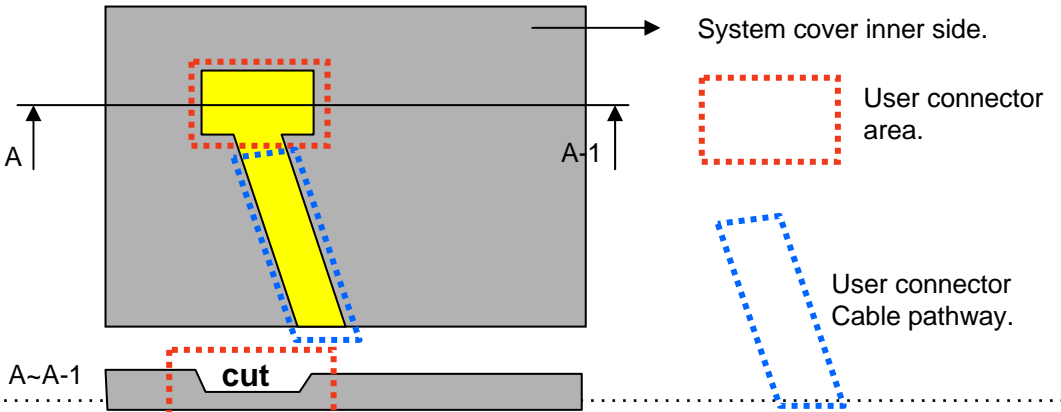
5	Using a bracket on the top of LCM is not recommended.	
<div style="display: flex; justify-content: space-around; align-items: center;"> <div style="text-align: center;">  <p>bracket</p>  <p>With bracket</p> </div> <div style="text-align: center;">  <p>Without bracket</p> </div> </div>		
Define	<p>1.Condition without bracket is good for mechanical noise,and can minimize the light leakage from deformation of bracket.</p> <p>2.The results shows that there is no difference between the condition with or without bracket.</p>	
6	Securing additional gap on CNT area..	
 <p style="text-align: right;">System cover inner side.</p> <p style="text-align: right;">User connector area.</p> <p style="text-align: right;">User connector Cable pathway.</p> <p style="text-align: right;">FPC:Flexible Printed Circuit.</p>		
Define	<p>1.CNT area is specially sensitive against external stress,and additional gap by cutting on system cover will be helpful on removing the Ripple.</p> <p>2.Using a thinner CNT will be better. (eg: FPC type)</p>	

Product Specification

6. Reliability

Environment test condition

No.	Test Item	Conditions
1	High temperature storage test	Ta= 60°C, 240h
2	Low temperature storage test	Ta= -20°C, 240h
3	High temperature operation test	Ta= 50°C, 50%RH, 240h
4	Low temperature operation test	Ta= 0°C, 240h
5	Vibration test (non-operating)	Sine wave, 10 ~ 500 ~ 10Hz, 1.5G, 0.37oct/min 3 axis, 1hour/axis
6	Shock test (non-operating)	Half sine wave, 180G, 2ms one shock of each six faces(I.e. run 180G, 2ms for all six faces)
7	Altitude operating storage / shipment	0 ~ 10,000 feet (3,048m) 24Hr 0 ~ 40,000 feet (12,192m) 24Hr

{ Result Evaluation Criteria }

There should be no change which might affect the practical display function when the display quality test is conducted under normal operating condition.

7. International Standards

7-1. Safety

- a) UL 60950-1:2003, First Edition, Underwriters Laboratories, Inc., Standard for Safety of Information Technology Equipment.
- b) CAN/CSA C22.2, No. 60950-1-03 1st Ed. April 1, 2003, Canadian Standards Association, Standard for Safety of Information Technology Equipment.
- c) EN 60950-1:2001, First Edition, European Committee for Electrotechnical Standardization(CENELEC) European Standard for Safety of Information Technology Equipment.

7-2. EMC

- a) ANSI C63.4 "Methods of Measurement of Radio-Noise Emissions from Low-Voltage Electrical and Electrical Equipment in the Range of 9kHz to 40GHz." American National Standards Institute(ANSI), 1992
- b) C.I.S.P.R "Limits and Methods of Measurement of Radio Interface Characteristics of Information Technology Equipment." International Special Committee on Radio Interference.
- c) EN 55022 "Limits and Methods of Measurement of Radio Interface Characteristics of Information Technology Equipment." European Committee for Electrotechnical Standardization.(CENELEC), 1998 (Including A1: 2000)

8. Packing

8-1. Designation of Lot Mark

a) Lot Mark

A	B	C	D	E	F	G	H	I	J	K	L	M
---	---	---	---	---	---	---	---	---	---	---	---	---

A,B,C : SIZE(INCH)
 E : MONTH

D : YEAR
 F ~ M : SERIAL NO.

Note

1. YEAR

Year	2001	2002	2003	2004	2005	2006	2007	2008	2009	2010
Mark	1	2	3	4	5	6	7	8	9	0

2. MONTH

Month	Jan	Feb	Mar	Apr	May	Jun	Jul	Aug	Sep	Oct	Nov	Dec
Mark	1	2	3	4	5	6	7	8	9	A	B	C

b) Location of Lot Mark

Serial No. is printed on the label. The label is attached to the backside of the LCD module.
 This is subject to change without prior notice.

8-2. Packing Form

a) Package quantity in one box : 20 pcs

b) Box Size : 395mm × 390mm × 306mm

9. PRECAUTIONS

Please pay attention to the followings when you use this TFT LCD module.

9-1. MOUNTING PRECAUTIONS

- (1) You must mount a module using holes arranged in four corners or four sides.
- (2) You should consider the mounting structure so that uneven force (ex. Twisted stress) is not applied to the module. And the case on which a module is mounted should have sufficient strength so that external force is not transmitted directly to the module.
- (3) Please attach the surface transparent protective plate to the surface in order to protect the polarizer. Transparent protective plate should have sufficient strength in order to resist external force.
- (4) You should adopt radiation structure to satisfy the temperature specification.
- (5) Acetic acid type and chlorine type materials for the cover case are not desirable because the former generates corrosive gas of attacking the polarizer at high temperature and the latter causes circuit break by electro-chemical reaction.
- (6) Do not touch, push or rub the exposed polarizers with glass, tweezers or anything harder than HB pencil lead. And please do not rub with dust clothes with chemical treatment. Do not touch the surface of polarizer for bare hand or greasy cloth.(Some cosmetics are detrimental to the polarizer.)
- (7) When the surface becomes dusty, please wipe gently with absorbent cotton or other soft materials like chamois soaks with petroleum benzene. Normal-hexane is recommended for cleaning the adhesives used to attach front / rear polarizers. Do not use acetone, toluene and alcohol because they cause chemical damage to the polarizer.
- (8) Wipe off saliva or water drops as soon as possible. Their long time contact with polarizer causes deformations and color fading.
- (9) Do not open the case because inside circuits do not have sufficient strength.

9-2. OPERATING PRECAUTIONS

- (1) The spike noise causes the mis-operation of circuits. It should be lower than following voltage :
 $V = \pm 200\text{mV}$ (Over and under shoot voltage)
- (2) Response time depends on the temperature.(In lower temperature, it becomes longer.)
- (3) Brightness depends on the temperature. (In lower temperature, it becomes lower.)
And in lower temperature, response time(required time that brightness is stable after turned on) becomes longer.
- (4) Be careful for condensation at sudden temperature change. Condensation makes damage to polarizer or electrical contacted parts. And after fading condensation, smear or spot will occur.
- (5) When fixed patterns are displayed for a long time, remnant image is likely to occur.
- (6) Module has high frequency circuits. Sufficient suppression to the electromagnetic interference shall be done by system manufacturers. Grounding and shielding methods may be important to minimized the interference.

9-3. ELECTROSTATIC DISCHARGE CONTROL

Since a module is composed of electronic circuits, it is not strong to electrostatic discharge. Make certain that treatment persons are connected to ground through wrist band etc. And don't touch interface pin directly.

9-4. PRECAUTIONS FOR STRONG LIGHT EXPOSURE

Strong light exposure causes degradation of polarizer and color filter.

9-5. STORAGE

When storing modules as spares for a long time, the following precautions are necessary.

- (1) Store them in a dark place. Do not expose the module to sunlight or fluorescent light. Keep the temperature between 5°C and 35°C at normal humidity.
- (2) The polarizer surface should not come in contact with any other object.
It is recommended that they be stored in the container in which they were shipped.

9-6. HANDLING PRECAUTIONS FOR PROTECTION FILM

- (1) When the protection film is peeled off, static electricity is generated between the film and polarizer.
This should be peeled off slowly and carefully by people who are electrically grounded and with well ion-blown equipment or in such a condition, etc.
- (2) The protection film is attached to the polarizer with a small amount of glue. If some stress is applied to rub the protection film against the polarizer during the time you peel off the film, the glue is apt to remain on the polarizer.
Please carefully peel off the protection film without rubbing it against the polarizer.
- (3) When the module with protection film attached is stored for a long time, sometimes there remains a very small amount of glue still on the polarizer after the protection film is peeled off.
- (4) You can remove the glue easily. When the glue remains on the polarizer surface or its vestige is recognized, please wipe them off with absorbent cotton waste or other soft material like chamois soaked with normal-hexane.

APPENDIX A. Enhanced Extended Display Identification Data (EEDID™) 1/3

TENTATIVE

APPENDIX A. Enhanced Extended Display Identification Data (EEDID™) 2/3

TENTATIVE

APPENDIX A. Enhanced Extended Display Identification Data (EEDID™) 3/3

TENTATIVE